



JQE Power Supplies

JQE MODEL TABLE

MODEL	d-c OUTPUT RANGE		OUTPUT IMPEDANCE				MAX. INPUT AMPS at 125V a-c
	VOLTS	AMPS	VOLTAGE MODE		CURRENT MODE		
			SERIES R	SERIES L ⁽¹⁾	SHUNT R	SHUNT C ⁽²⁾	
QUARTER-RACK							
JQE 6-10M	0-6	0-10	30μΩ	1μH	50kΩ	3kμF	2.0
JQE 15-6M	0-15	0-6	125μΩ	1μH	84kΩ	1kμF	2.1
JQE 25-4M	0-25	0-4	300μΩ	1μH	125kΩ	700μF	2.2
JQE 36-3M	0-36	0-3	600μΩ	1μH	165kΩ	400μF	2.2
JQE 55-2M	0-55	0-2	1.4mΩ	1μH	250kΩ	220μF	2.3
JQE 75-1.5M	0-75	0-1.5	2.5mΩ	1μH	330kΩ	160μF	2.3
JQE 100-1M	0-100	0-1	5mΩ	2μH	500kΩ	110μF	2.1
HALF-RACK							
JQE 6-22M	0-6	0-22	14μΩ	0.5μH	23kΩ	5.8kμF	4.2
JQE 6-45M	0-6	0-45	7μΩ	0.5μH	11kΩ	8kμF	9.0
JQE 15-12M	0-15	0-12	63μΩ	0.5μH	42kΩ	2.7kμF	4.0
JQE 15-25M	0-15	0-25	30μΩ	0.5μH	20kΩ	4.5kμF	8.4
JQE 25-10M	0-25	0-10	125μΩ	0.5μH	50kΩ	2.4kμF	5.3
JQE 25-20M	0-25	0-20	63μΩ	0.5μH	25kΩ	4.3kμF	10.5
JQE 36-8M	0-36	0-8	225μΩ	0.5μH	62.5kΩ	1.4kμF	6.0
JQE 36-15M	0-36	0-15	120μΩ	0.5μH	33kΩ	3.6kμF	9.5
JQE 55-5M	0-55	0-5	550μΩ	1μH	100kΩ	850μF	5.0
JQE 55-10M	0-55	0-10	275μΩ	1μH	50kΩ	2.1kμF	9.0
JQE 75-3M	0-75	0-3	1.25mΩ	1μH	165kΩ	850μF	4.0
JQE 75-8M	0-75	0-8	469μΩ	1μH	62.5kΩ	1.2kμF	10.0
JQE 100-2.5M	0-100	0-2.5	2mΩ	1μH	200kΩ	600μF	4.5
JQE 100-5M	0-100	0-5	1.25mΩ	1μH	100kΩ	600μF	8.4
JQE 150-1.5M	0-150	0-1.5	5mΩ	2μH	330kΩ	440μF	4.6
JQE 150-3.5M	0-150	0-3.5	2.2mΩ	2μH	140kΩ	440μF	8.7
FULL-RACK							
JQE 6-90M	0-6	0-90	3.5μΩ	0.5μH	3.5kΩ	17.6kμF	15.7
JQE 15-50M	0-15	0-50	15μΩ	0.5μH	10kΩ	12kμF	16.6
JQE 25-40M	0-25	0-40	31μΩ	0.5μH	12.5kΩ	14kμF	21.0
JQE 36-30M	0-36	0-30	60μΩ	0.5μH	16kΩ	11kμF	19.0
JQE 55-20M	0-55	0-20	138μΩ	1μH	25kΩ	7.3kμF	18.0
JQE 75-15M	0-75	0-15	250μΩ	1μH	33kΩ	4.2kμF	18.0
JQE 100-10M	0-100	0-10	0.62mΩ	1μH	50kΩ	2.2kμF	17.0
JQE 150-7M	0-150	0-7	1.1mΩ	2μH	72kΩ	1kμF	18.0

(1) For determining dynamic impedance in voltage mode.

(2) For determining dynamic impedance in current mode.

Series JQE power supplies are systems-type voltage stabilizers with current limiting. They are available in a variety of ratings: 100 watts in a 1/4-rack package, 250-500 watts in a 1/2-rack package, and 1000 watts in a full-rack package.

The tabulation of the effective series resistance and inductance in voltage mode and the effective shunt resistance and shunt capacitance in current mode, is done to allow a calculation of the output impedance versus frequency.

FEATURES

- 10 turn voltage control for exceptional resolution.
- Analog output control by resistance: 1000Ω/Volt; or by a voltage delivering 0-1mA.
- Digital listen only control using SN-series digital interfaces.
- Current limited, front panel control (not programmable) 10%-105% I_O max.
- JQE can control current with an external current-sense resistor.





Model JQE 25-4M Quarter Rack



Model JQE 100-2.5M Half Rack

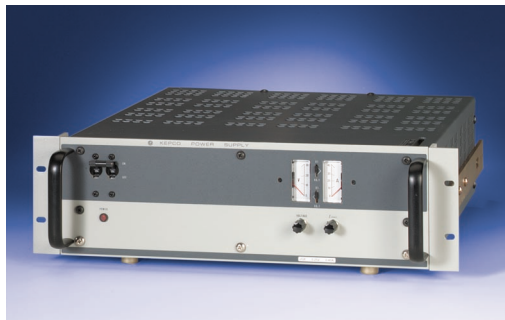

Model JQE 25-40M Full Rack



JQE are CE marked per the Low Voltage Directive (LVD), EN61010-1.



JQE GENERAL SPECIFICATIONS

SPECIFICATION	RATING/DESCRIPTION	CONDITION	
INPUT			
a-c Voltage	105-125, 210-250V a-c	User selectable	
Current	See model table	Max load, 115V a-c	
Frequency	47-65Hz	Range	
OUTPUT			
d-c Output	Series pass	Transistor	
Type of Stabilizer	Voltage stabilizer	Current limited	
Voltage	0 to 100% of rating	Adjustment range for temp 0-71°C	
Current	0 to 100% of rating		
Error Sense	0.5V per load wire	Static voltage allowance	
Isolation Voltage	500V d-c or peak	Output to ground	
Leakage Current	<5 microamperes	rms at 115V a-c	
Output to Ground	<50 microamperes	p-p at 115V a-c	
Series Connection	500V	Max voltage off ground	
Parallel Connection	Automatic	Use current mode limiting	
	Current sharing	Use master-slave connection	
	Redundancy type	External steering diodes	
OVP	Not available		
CONTROL			
Type	Voltage	Fixed input, variable gain	
	Current	Differential comparison	
Voltage	Local	10-turn precision rheostat	
	Remote Analog	1000 ohms per volt or 0 to 1mA control current	
	Remote Digital	Use SN/SNR interface	12 bit Listen-only
Current	Local	Multiturn pot	
	Remote Analog	Not provided	See Series ATE models
Dynamics	Normal (slow)	dV/dt = I/C	See tabulated value of C in the model table
	Fast mode	Not provided	See Series ATE models
MECHANICAL			
Input Connection	Detachable IEC type 3-wire	¼ and ½ rack size	
	Permanently wired	Full rack size	
Output Connections	Front panel binding posts	Models under 15A	
	Rear barrier strip	¼ and ½ size	
	Rear compression studs	Full rack size	
Meters	Two 1½" vertical 3%, analog	Front panel	
Indicators	Neon	Pilot	
Mounting (in std 19" racks)	Use RA 24 rack adapter	¼ and ½ size	
	Mounting "ears" provided	Full rack	
Cooling	Forced air	Exhaust to rear	
Dimensions (HxWxD)	inches	5 ⁷ / ₃₂ x 4 ⁹ / ₃₂ x 17 ³ / ₁₆	¼ rack size
	mm	132.6 x 105.6 x 436.6	
	inches	5 ⁷ / ₃₂ x 8 ¹ / ₃₂ x 17 ³ / ₈	½ rack size
mm	132.6 x 211.9 x 441.3		
inches	5 ⁷ / ₃₂ x 19 x 17 ¹ / ₄	Full rack size	
mm	177 x 482.6 x 504.8		
Finish: Fed Std 595	Light gray, color 26440	Front panel, 2 tone	
Weight (packed for shipment)	18lb (8.2Kg)	¼ rack size	
	37lb (16.8Kg)	½ rack size (250W)	
	49lb (22.3Kg)	½ rack size (500W)	
	97lb (44.1Kg)	Full rack size	

JQE STATIC SPECIFICATIONS

INFLUENCE QUANTITY	OUTPUT EFFECTS		AMPLIFIER OFFSETS ⁽⁶⁾		REFERENCE 6.2V±5%
	VOLTAGE MODE	CURRENT MODE ⁽¹⁾	VOLTAGE ΔE_{IO}	CURRENT ΔI_{IO}	
Source 105-125/210V a-c	<0.0005%	<0.005%	<10 μ V	<2nA	0.0001%
Load No load-full load	<0.005% or 0.2mV ⁽²⁾	<0.01%	<200 μ V	<5nA	—
Time 8-hours (drift)	<0.01% or 1mV ⁽²⁾	>0.02%	<20 μ V	<2nA	0.005%
Temp. Per °C	<0.01% ⁽³⁾	<0.02% ⁽³⁾	<20 μ V	<5nA	0.005%
Ripple and Noise ⁽⁴⁾	rms p-p ⁽⁵⁾	<0.2mV <0.1% of I_O max.	—	—	—

- (1) External current sensing, using the voltage amplifier. Effects are measured for a 1-Volt current sensing voltage drop.
- (2) Whichever is greater.
- (3) Typical temperature effect coefficients are: 0.005% per °C voltage mode; 0.01% per °C externally sensed current mode.
- (4) One terminal grounded or connected so that the common-mode current does not flow through the load or (in current-mode) through a sensing resistor.
- (5) 20Hz to 10MHz.
- (6) The output effect can be calculated by the relationship:
 $\Delta E_O = \pm E_r(R_f/R_i) \pm \Delta E_{IO}(1+R_f/R_i) \pm I_{IO}(R_f)$ where R_f is the feedback resistor, and R_i is the input resistor from the reference, E_r .

The tabulated offsets, more particularly their change as a function of source, time and temperature, allow a user to calculate performance of the uncommitted amplifier(s) with user specified input and feedback components. The formula for this is given in the static specifications table footnote.

OUTLINE DIMENSIONAL DRAWINGS

Fractional dimensions in light face type are in inches, dimensions in bold face type are in millimeters.

Tolerance: $\pm 1/64"$ (0.4) between mounting holes
 $\pm 1/32"$ (0.8) other dimensions
 Panels: Per Mil. Std. 189

The 1/4 rack and 1/2 rack size JQE power supplies can be rack mounted using RA 24. See page 77.

JQE QUARTER-RACK MODELS

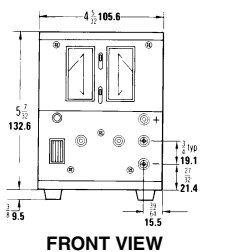

FRONT VIEW

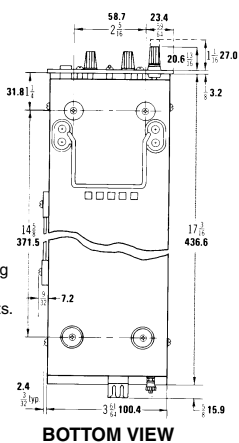

BOTTOM VIEW

To rack mount, remove handle, feet and bail. Use (4) 8-18 x 5/8" thread cutting screws into plastic inserts.

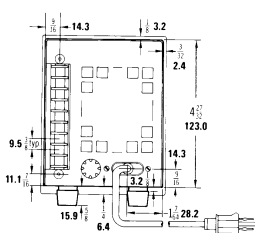

REAR VIEW

JQE HALF-RACK MODELS

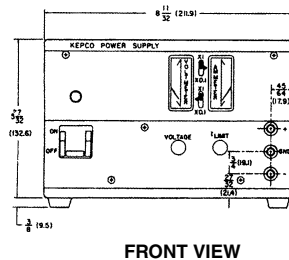

FRONT VIEW

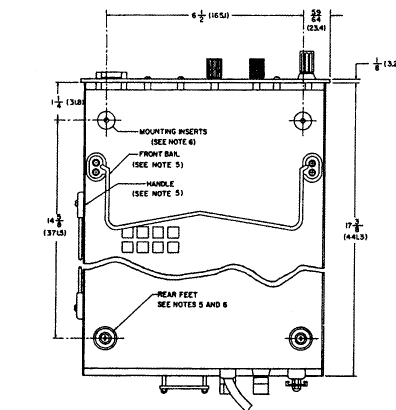

BOTTOM VIEW

To rack mount, remove handle, feet and bail. Use (4) 8-18 x 5/8" thread cutting screws into plastic inserts.

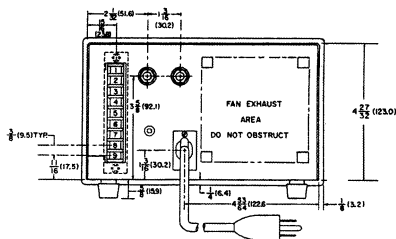

REAR VIEW

JQE FULL-RACK MODELS

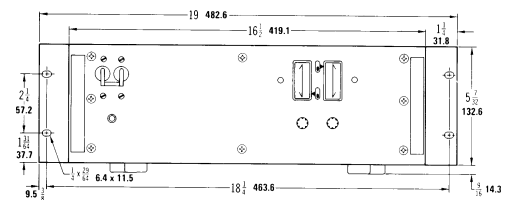

FRONT VIEW

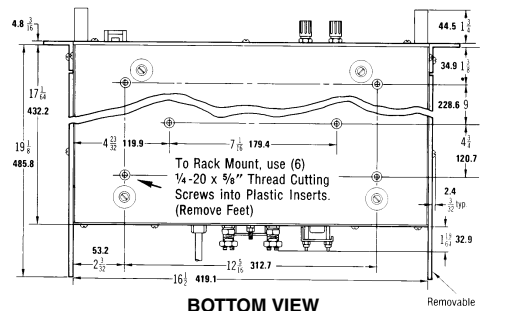

BOTTOM VIEW

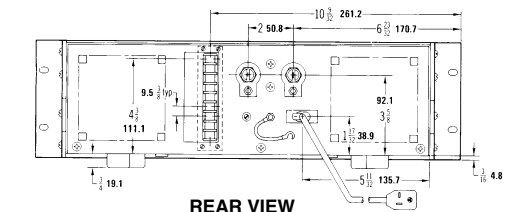

REAR VIEW

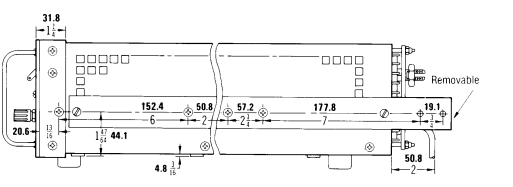

SIDE VIEW

Available from



CALTEST
Instruments Ltd
Specialists in power
and instrumentation

Power sources and test instrumentation solutions

Caltest have been providing power sources and test instrumentation solutions for over 20 years and are proud to represent a number of industry leading manufacturers.

As well as supplying world class power sources and test instrumentation Caltest also has a service centre and UKAS calibration laboratory.

NEED HELP?

CALL US:

01483 302 700

or visit our website for more details

Caltest Instruments Ltd
4 Riverside Business Centre
Walnut Tree Close
Guildford
Surrey GU1 4UG
United Kingdom

Tel: +44 (0) 1483 302 700

Fax: +44 (0) 1483 300 562

sales@caltest.co.uk

www.caltest.co.uk

Sales • Rentals • Service • UKAS Calibration

